

Bezel and Stuffer Caps are included with jack. Custom Bezels ordered separately.

Hold jack & cable in one hand. Load 110 Connectors and terminate with other hand.

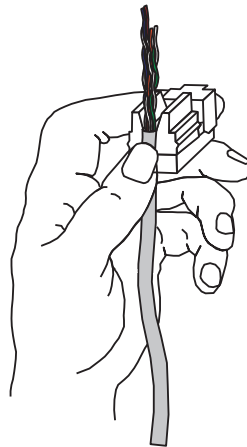

- STEP 1: Strip back cable jacket 1 1/2".
- STEP 2: Press cable into slot at back of connector.
- STEP 3: Insert conductors into color coded slots on 110 Connectors. Maintain wire twists up to termination point.

- STEP 4: Terminate conductors using 110 impact tool or stuffer caps (provided) and pliers.
- STEP 5: Trim excess conductors.
- STEP 6: Snap into Faceplate.
- STEP 7: Push on Bezel.

KMJL Punch-Down

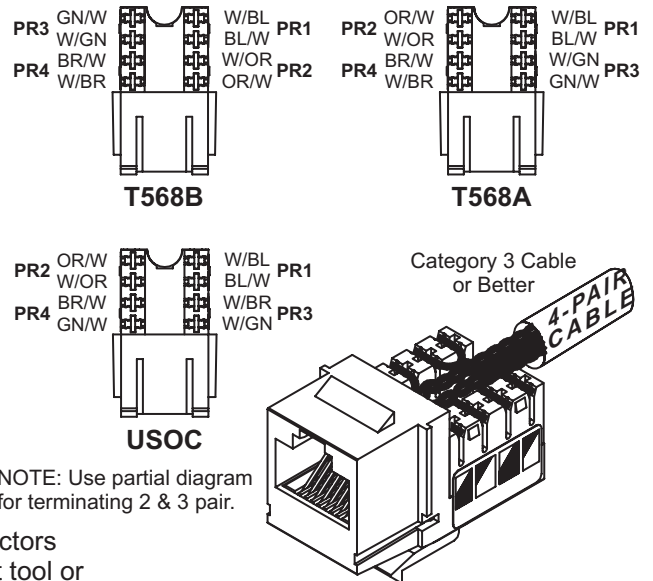

NOTE: Use partial diagram for terminating 2 & 3 pair.

NOTE: Installer MUST follow EIA/TIA 568 Installation Guidelines to maintain Category 3 Compliance.

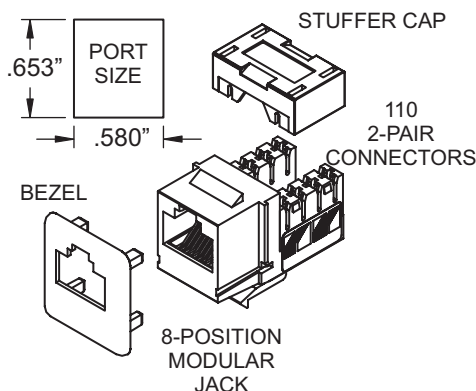

Bezel and Stuffer Caps are included with jack. Custom Bezels ordered separately.

Hold jack & cable in one hand. Load 110 Connectors and terminate with other hand.

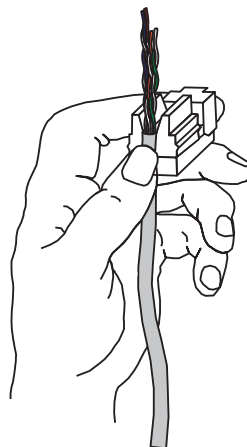

- STEP 1: Strip back cable jacket 1 1/2".
- STEP 2: Press cable into slot at back of connector.
- STEP 3: Insert conductors into color coded slots on 110 Connectors. Maintain wire twists up to termination point.

- STEP 4: Terminate conductors using 110 impact tool or stuffer caps (provided) and pliers.
- STEP 5: Trim excess conductors.
- STEP 6: Snap into Faceplate.
- STEP 7: Push on Bezel.

KMJL Punch-Down

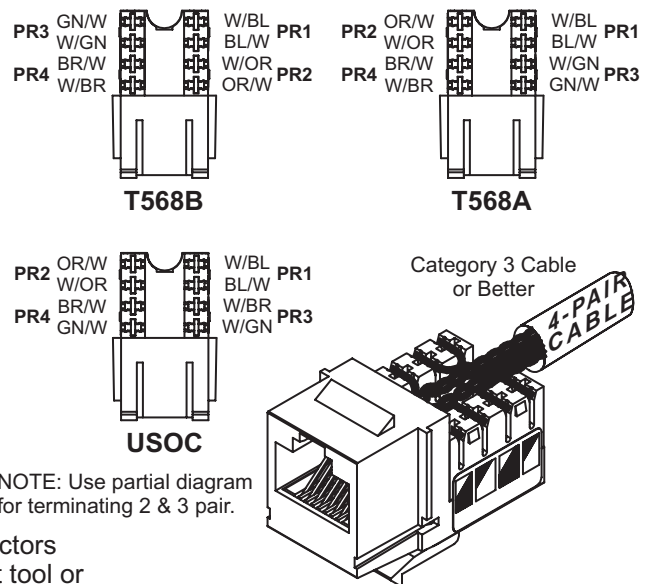

NOTE: Use partial diagram for terminating 2 & 3 pair.

NOTE: Installer MUST follow EIA/TIA 568 Installation Guidelines to maintain Category 3 Compliance.

Wiring Patterns and Part Numbers

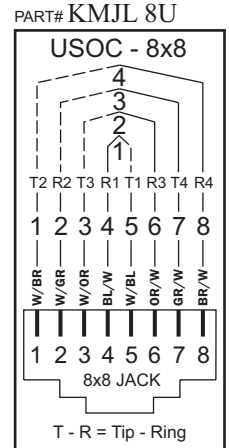
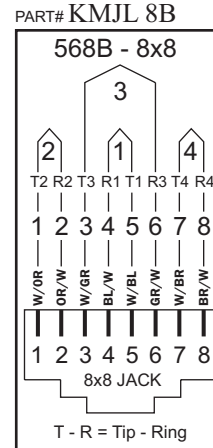
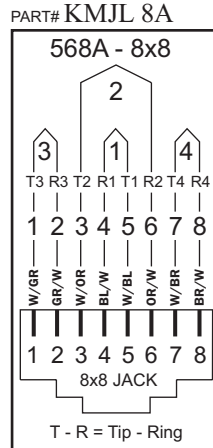
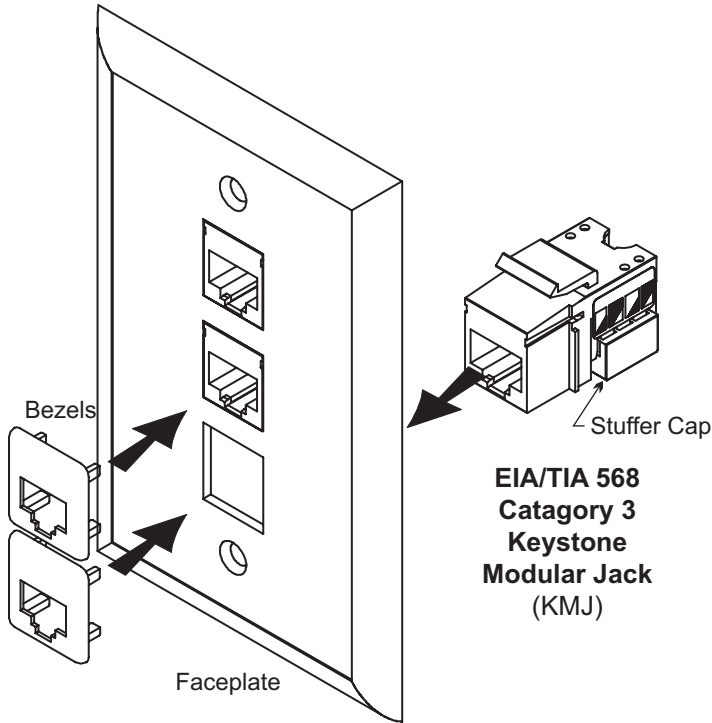

NOTE: Use partial diagram for terminating 2 & 3 pair.

5290 Concourse Drive • Roanoke, VA 24019 USA
Phone: 540-265-0690 • TOLL FREE 800-622-7711
Fax: 540-265-0724 • www.occfiber.com

Wiring Patterns and Part Numbers

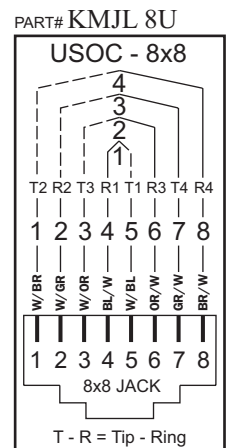
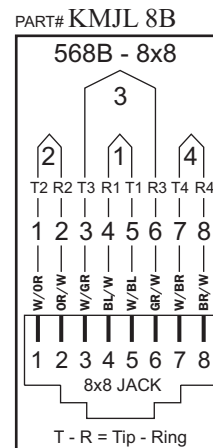
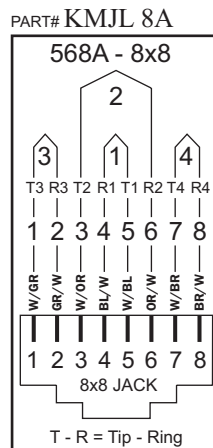
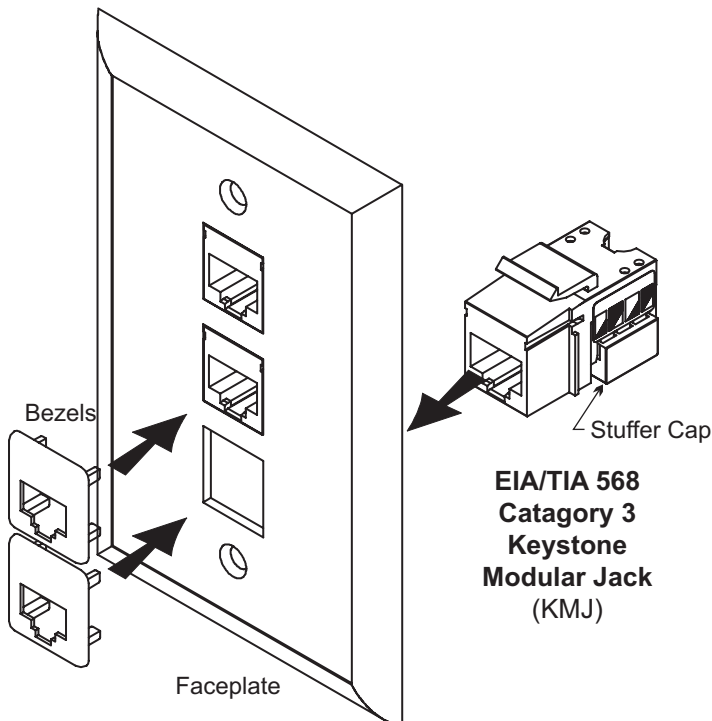

NOTE: Use partial diagram for terminating 2 & 3 pair.

5290 Concourse Drive • Roanoke, VA 24019 USA
Phone: 540-265-0690 • TOLL FREE 800-622-7711
Fax: 540-265-0724 • www.occfiber.com