

"OPTICAL CABLE CORPORATION (OCC)  
RESERVES THE RIGHT TO REVISE ANY  
AND ALL DESIGN SPECIFICATIONS."

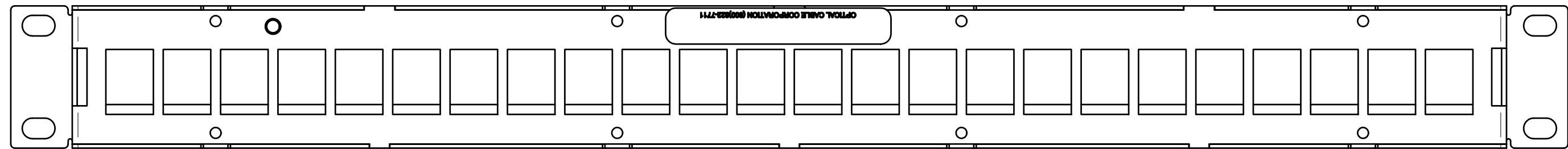

REAR VIEW

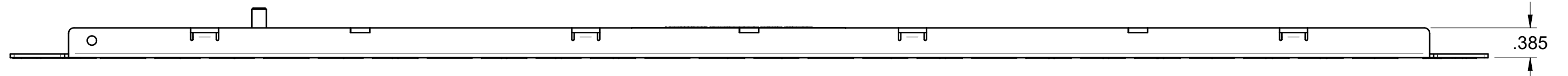

TOP VIEW

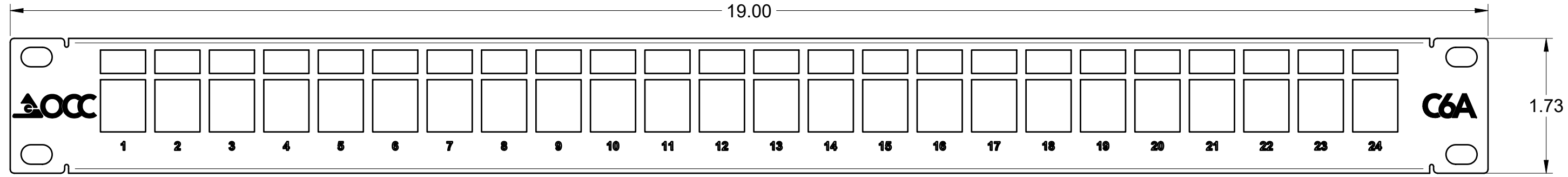

FRONT VIEW

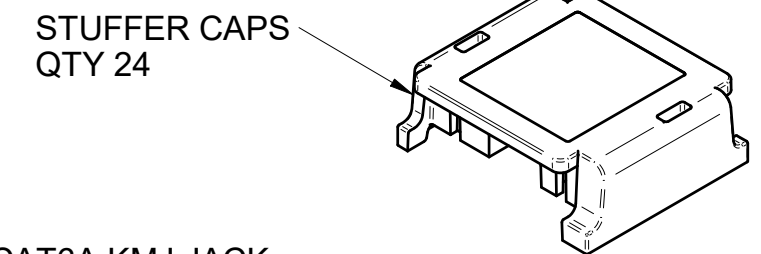

STUFFER CAPS  
QTY 24

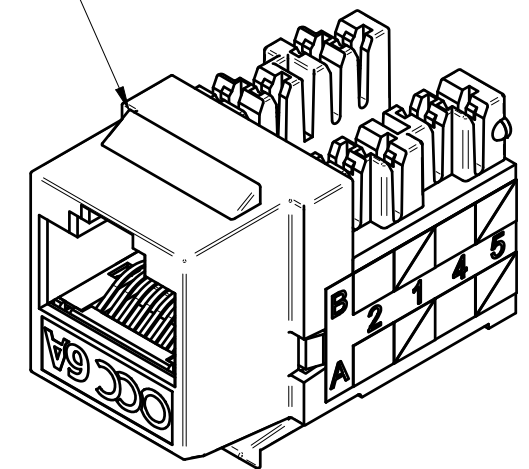

CAT6A KMJ JACK  
QTY 24

**APPLICATIONS:**

- ANALOG VOICE / VOIP
- VIDEO: IPTV / HDBaseT
- 10/100/1000/10GBASE-T ETHERNET
- IEEE 802.3 AF/AT/BT PoE

**SPECIFICATIONS:**

- ANSI / TIA-568-C.2 CATEGORY 6A
- ANSI / TIA-968-A
- IEC 60603-7

**MATERIALS:**

- PANEL: BLACK POWDER COAT, 16 & 18 AWG STEEL
- CABLE MANAGEMENT BARS, BLACK POWDER COAT, 16 AWG STEEL

**- KIT INCLUDES THE FOLLOWING:**

- (24) CAT6A JACKS (K6A02) SHIPPED LOOSE
- (6) 3.6 " NYLON CABLE TIES
- (4) BLACK 12-24 PAN HEAD SCREWS
- (1) CABLE MANAGEMENT BAR
- PRODUCT APPROVAL REQUIRES CERTIFICATION OF COMPLIANCE TO E.U. RoHS DIRECTIVE 2002/95/EC.

CABLE MGMT BAR  
QTY 1

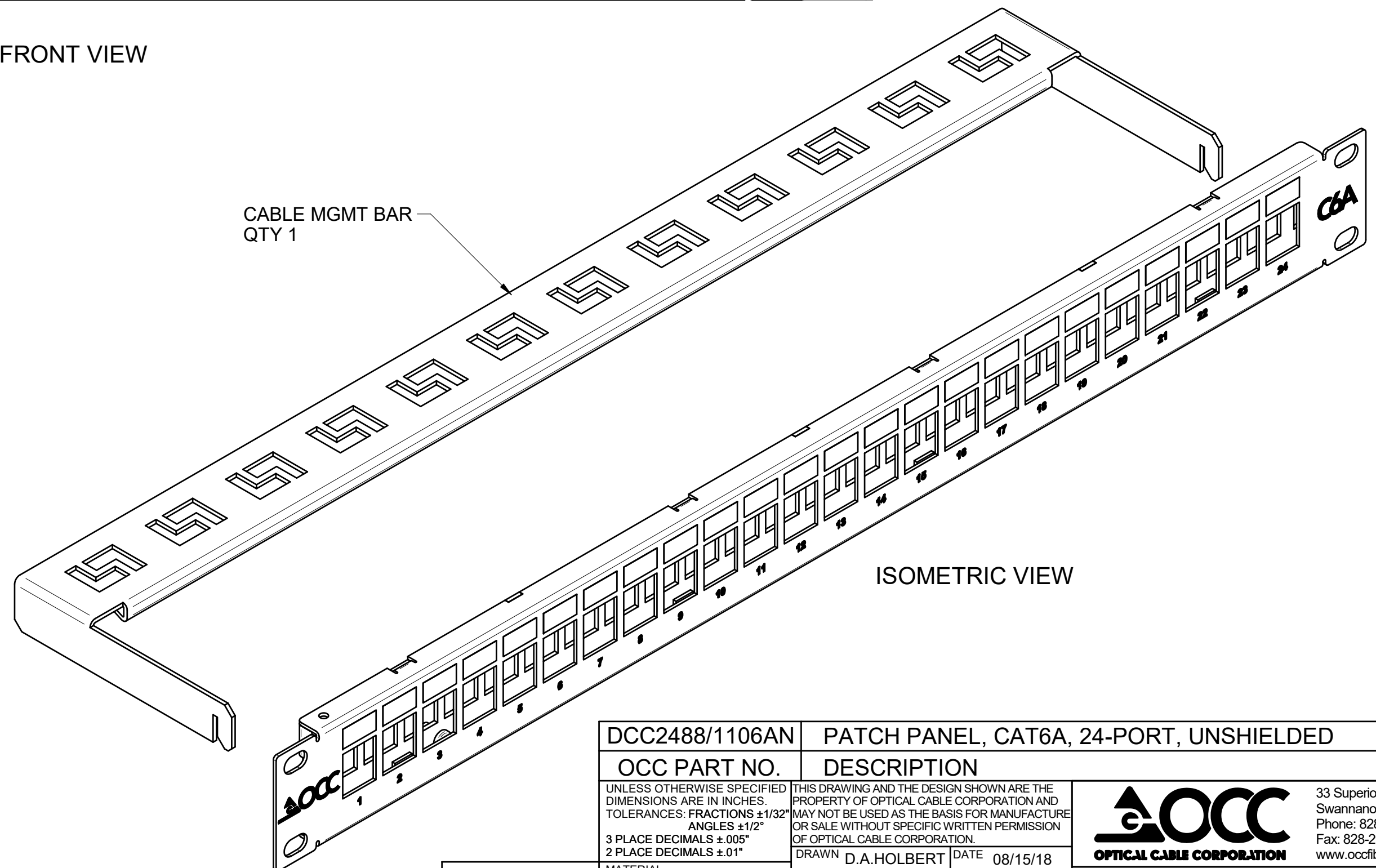

ISOMETRIC VIEW

**UNCONTROLLED COPY**

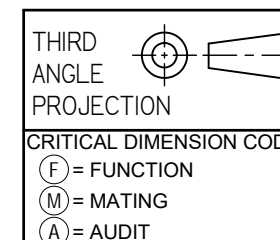

DCC2488/1106AN		PATCH PANEL, CAT6A, 24-PORT, UNSHIELDED	
OCC PART NO.		DESCRIPTION	
UNLESS OTHERWISE SPECIFIED DIMENSIONS ARE IN INCHES. TOLERANCES: FRACTIONS ±1/32" ANGLES ±1/2° 3 PLACE DECIMALS ±.005" 2 PLACE DECIMALS ±.01"		THIS DRAWING AND THE DESIGN SHOWN ARE THE PROPERTY OF OPTICAL CABLE CORPORATION AND MAY NOT BE USED AS THE BASIS FOR MANUFACTURE OR SALE WITHOUT SPECIFIC WRITTEN PERMISSION OF OPTICAL CABLE CORPORATION.	
DRAWN	D.A.HOLBERT	DATE	08/15/18
CHECKED	STIKELEATHER	DATE	08/15/18
ENGINEER	J.YANIK	DATE	08/15/18
APPROVED	J.CALLOWAY	DATE	08/15/18
PREVIOUS DWG		SIZE	C
NEXT DWG	FILENAME C113140A.DFT	SCALE:	NONE
DWG TITLE		DWG NO.	REV
PATCH PANEL, CAT6A, 24 PORT, UTP		<b>C113140</b>	A
SHEET		1 OF 1	

**OCC**  
OPTICAL CABLE CORPORATION  
33 Superior Way  
Swannanoa, NC 28778  
Phone: 828-298-2260  
Fax: 828-298-2487  
www.occfiber.com