

"OPTICAL CABLE CORPORATION (OCC)
RESERVES THE RIGHT TO REVISE ANY
AND ALL DESIGN SPECIFICATIONS."

UNCONTROLLED COPY

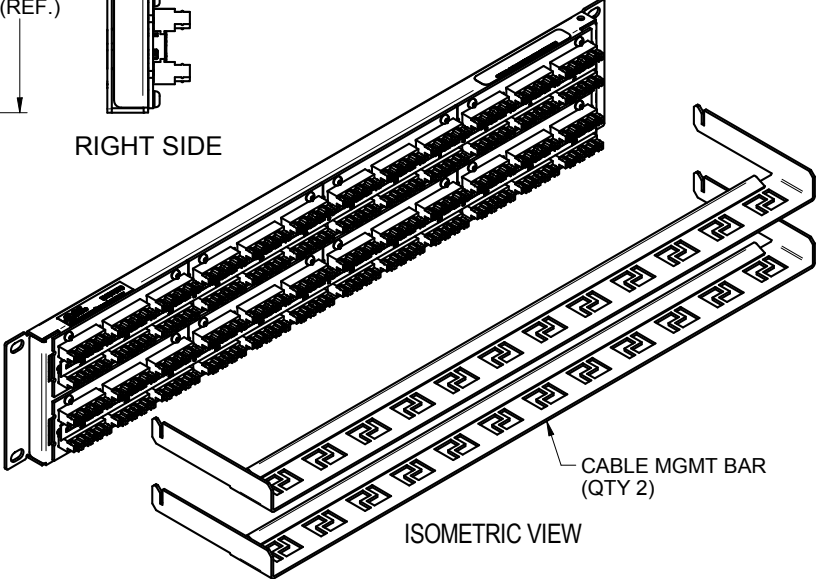
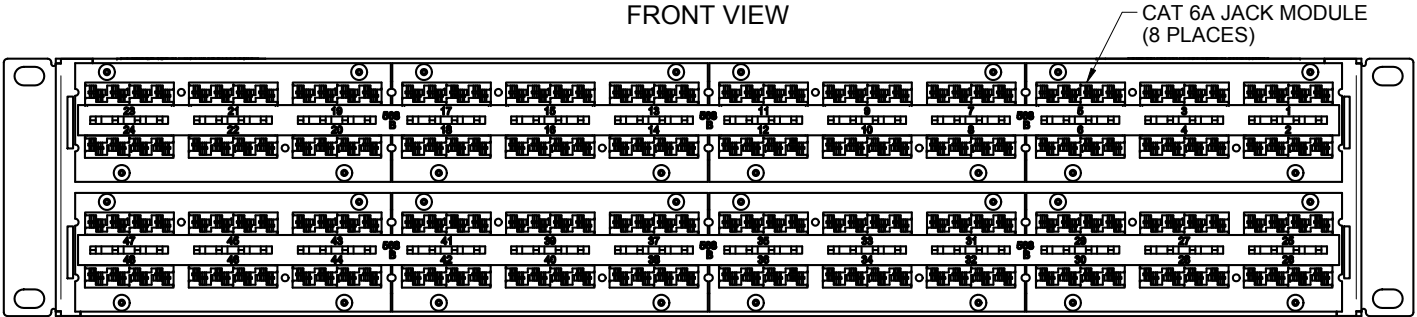
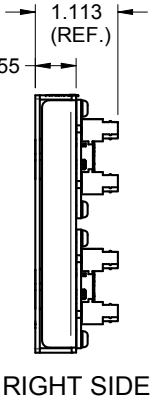
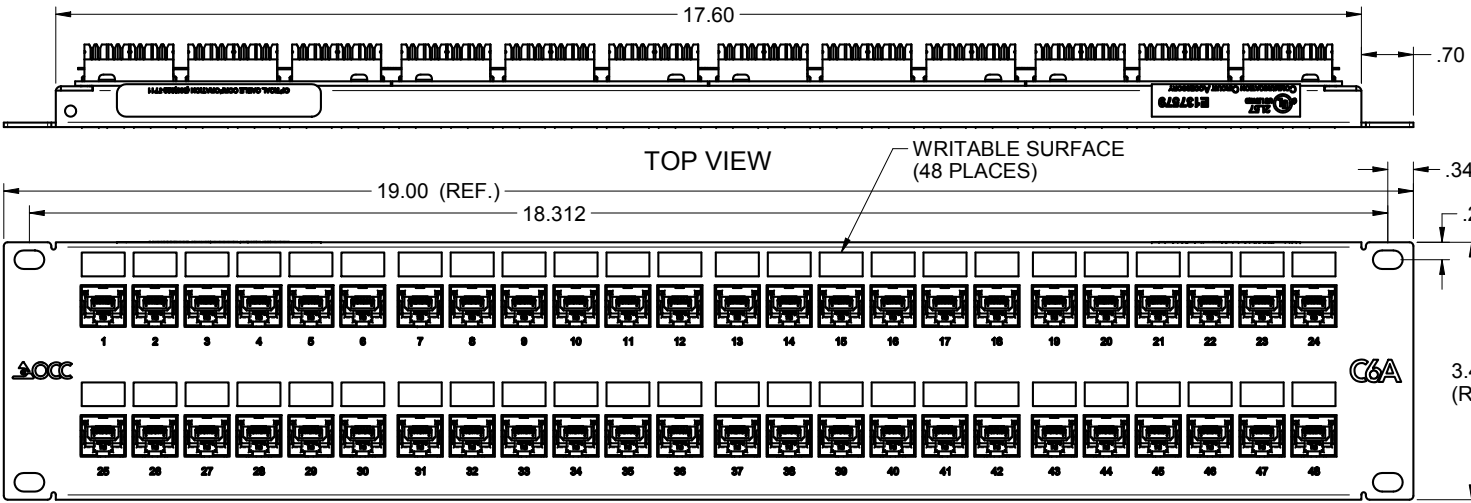

- APPLICATION:
- 2.5/5/10GBASE-T ETHERNET
 - IEEE 802.3BT PoE++

- SPECIFICATIONS:
- ANSI/TIA-568.2 CATEGORY 6A
 - ANSI/TIA-968-A
 - IEC 60603-7

- MATERIALS:
- PANEL: BLACK POWDERCOAT, 16-GA CRS
 - CABLE MANAGEMENT BARS, BLACK POWDERCOAT, 16-GA STEEL
 - KIT INCLUDES THE FOLLOWING:
 - (12) 3.6" NYLON CABLE TIES
 - (4) BLACK #12-24 PANHEAD SCREWS
 - (2) CABLE MANAGEMENT BARS

BACK VIEW (ROTATED 180° DEGREES)

8 POSITION MODULAR JACK

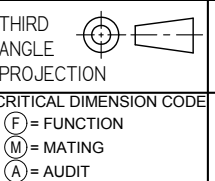
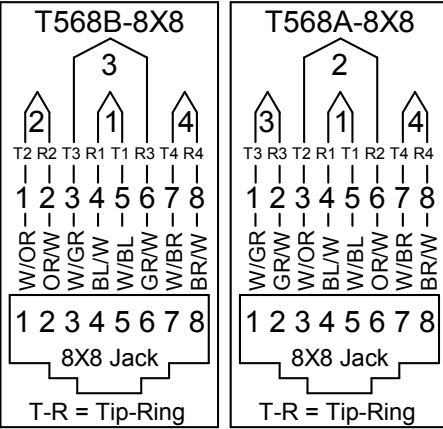

DCC4888/1106APD	PATCH PANEL, 48 PORT, CAT 6A, UTP, 110	
OCC PART NO.	DESCRIPTION	
UNLESS OTHERWISE SPECIFIED DIMENSIONS ARE IN INCHES. TOLERANCES: FRACTIONS ±1/32" ANGLES ±1/2° 3 PLACE DECIMALS ±.005" 2 PLACE DECIMALS ±.01"	THIS DRAWING AND THE DESIGN SHOWN ARE THE PROPERTY OF OPTICAL CABLE CORPORATION AND MAY NOT BE USED AS THE BASIS FOR MANUFACTURE OR SALE WITHOUT SPECIFIC WRITTEN PERMISSION OF OPTICAL CABLE CORPORATION.	
MATERIAL SEE NOTES	DRAWN D.A.HOLBERT	DATE 7/5/22
FINISH SEE NOTES	CHECKED J.HOWE	DATE 7/15/22
	ENGINEER J.YANIK	DATE 7/5/22
	APPROVED J.CALLOWAY	DATE 8/14/23
	PREVIOUS DWG	
	NEXT DWG	
	FILENAME C113780B.dft	SCALE: NONE SHEET 1 OF 1
	DWG TITLE CUSTOMER DRAWING, PATCH PANEL, 48P, C6A, UTP, 110	REV B
	SIZE B	DWG NO. C113780

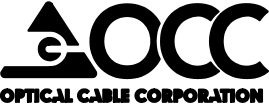

33 Superior Way
Swannanoa, NC 28778
Phone: 828-298-2260
Fax: 828-298-2487
www.occfiber.com

PROPRIETARY AND CONFIDENTIAL