

REVISION HISTORY				
REV	SHT	DESCRIPTION	DATE	CHECKED
A	ALL	RELEASE NEW	1/26/05	RBS

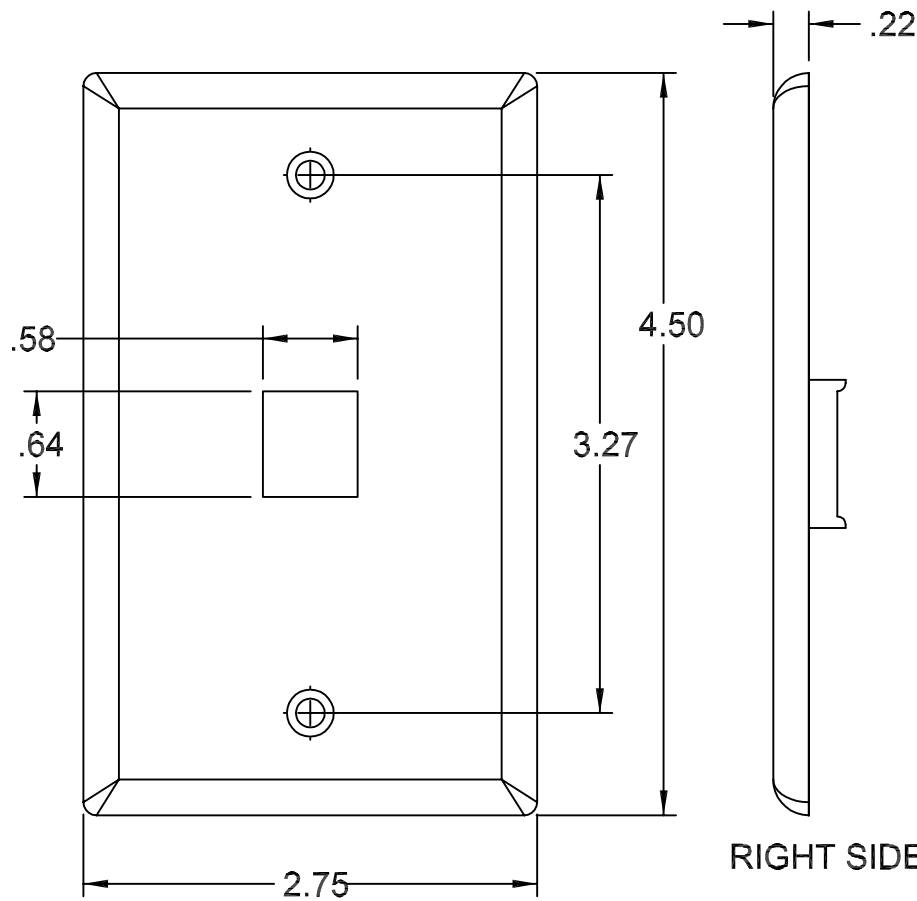

FRONT VIEW

RIGHT SIDE

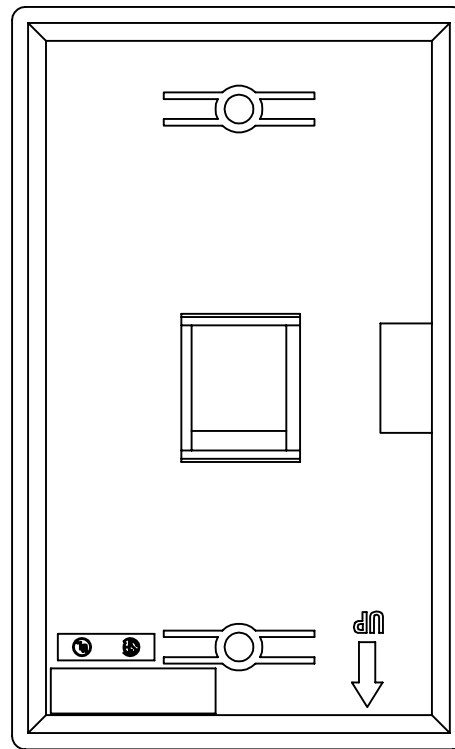

REAR VIEW

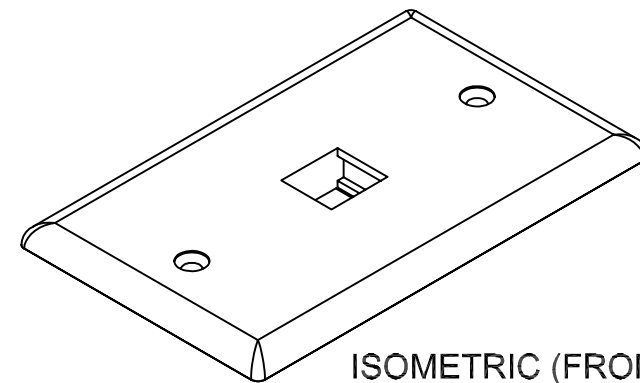

ISOMETRIC (FRONT)

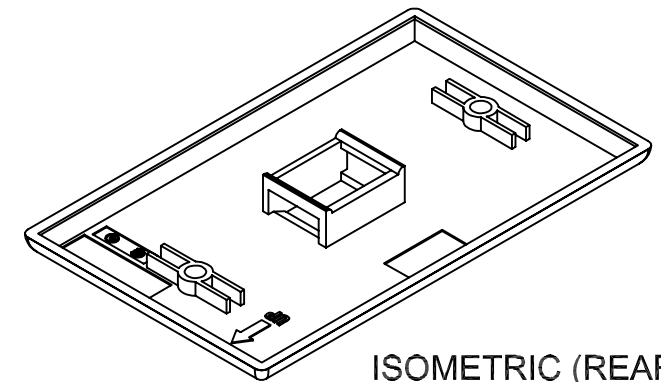

ISOMETRIC (REAR)

NOTES: UNLESS OTHERWISE SPECIFIED.

1. FACEPLATE ASSEMBLIES ARE PROVIDED WITH (1 each) HARDWARE KIT.

FPKS0112	ASSY, FACEPLATE, SG, FM, 1 PORT KMJ, STANDARD, BRIGHT WHITE, RESIDENTIAL
FPKS0101	ASSY, FACEPLATE, SG, FM, 1 PORT KMJ, STANDARD, OFFICE WHITE, RESIDENTIAL
FPKS0100	ASSY, FACEPLATE, SG, FM, 1 PORT KMJ, STANDARD, ELEC. IVORY, RESIDENTIAL
OCC PART NO.	DESCRIPTION

UNCONTROLLED COPY

UNLESS OTHERWISE SPECIFIED DIMENSIONS ARE IN INCHES.
TOLERANCES: FRACTIONS $\pm 1/32"$
ANGLES $\pm 1/2^\circ$
3 PLACE DECIMALS $\pm .005"$
2 PLACE DECIMALS $\pm .01"$

THIS DRAWING AND THE DESIGN SHOWN ARE THE PROPERTY OF OPTICAL CABLE CORPORATION AND MAY NOT BE USED AS THE BASIS FOR MANUFACTURE OR SALE WITHOUT SPECIFIC WRITTEN PERMISSION OF OPTICAL CABLE CORPORATION.

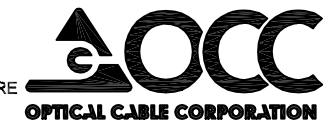

33 Superior Way
Swannanoa, NC 28778
Phone: 828-298-2260
Fax: 828-298-2487
www.occfiber.com

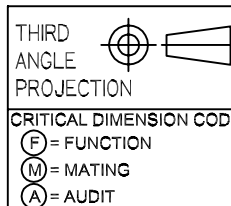

MATERIAL
SEE BILL OF MATERIAL

FINISH
SEE NOTES; FOR COLOR
SEE OCC SPEC# 100004

DRAWN	D.A.HOLBERT	DATE	1/26/05
CHECKED	R.B.SMITH	DATE	1/27/05
ENGINEER	J.YANIK	DATE	1/26/05
APPROVED	D.INGLE	DATE	1/27/05
PREVIOUS DWG			
NEXT DWG			

DWG TITLE			
CUSTOMER DRAWING, FACEPLATE ASSY, 1 PORT, KMJ, SG, FM, STD, RESIDENTIAL			
SIZE	DWG NO.	REV	
B	CI07130	A	
SCALE:	NONE	SHEET	1 OF 1
FILENAME	C107130A.DFT		