

REVISIONS					
REV	SHT	DESCRIPTION	DATE	ECN	CHECKED
A	ALL	RELEASE NEW	6/30/02	NEW	RBS

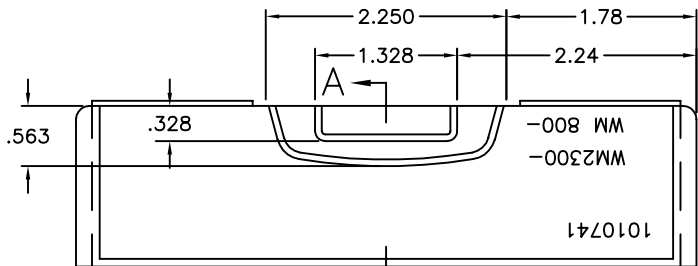

BACK VIEW

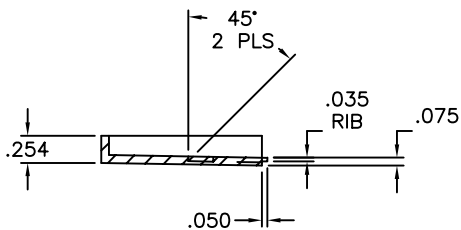

SECTION "A-A"

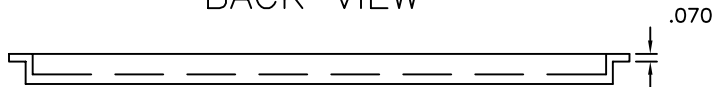

TOP VIEW

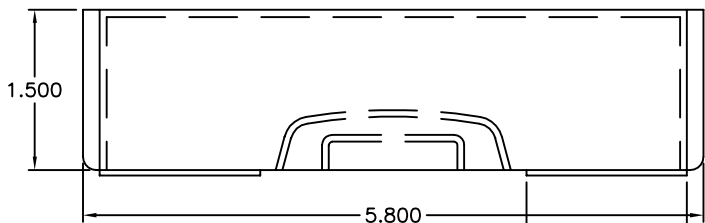

FRONT VIEW

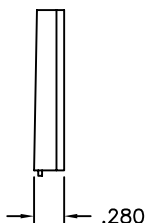

RIGHT SIDE

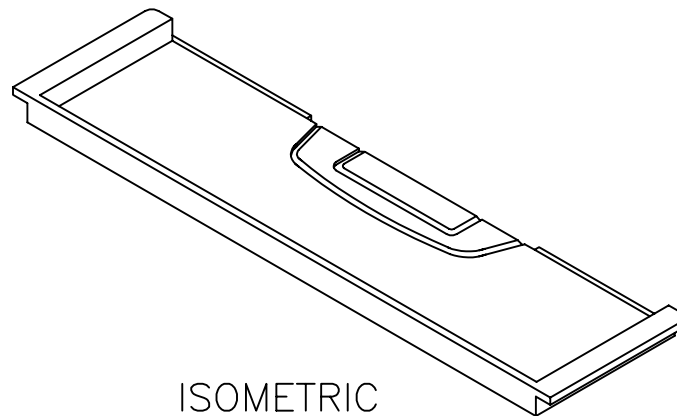

ISOMETRIC

UNCONTROLLED COPY

UNLESS OTHERWISE SPECIFIED DIMENSIONS ARE IN INCHES
 TOLERANCES:
 FRACTIONS ±1/32"
 ANGLES ±1/2"
 3 PLACE DECIMALS ±.005"
 2 PLACE DECIMALS ±.01"

THIS DRAWING AND THE DESIGN SHOWN ARE THE PROPERTY OF OPTICAL CABLE CORPORATION AND MAY NOT BE USED AS THE BASIS FOR MANUFACTURE OR SALE WITHOUT SPECIFIC WRITTEN PERMISSION OF OPTICAL CABLE CORPORATION.

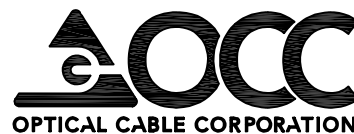

5290 Concourse Drive
 Roanoke, VA 24019
 Phone: 800-622-7711
 Fax: 540-265-0724
 www.occfiber.com

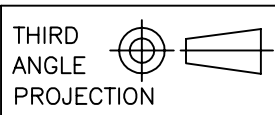

THIRD ANGLE PROJECTION

MATERIAL CATEGORY: THERMOPLASTIC
 COLOR SPEC: SEE OCC DRAWING #100004

DRAWN BY	D.A.HOLBERT	DATE	6/30/02
CHECKED BY	R.B.SMITH	DATE	7/8/02
ENGINEER	J.YANIK	DATE	6/30/02
APPROVED	H.JOHNSON	DATE	6/23/10
PREVIOUS DWG			
NEXT DWG			

DWG TITLE
 MULTIMEDIA PLATE, WM,
 RACEWAY, BLANK

CRITICAL DIMENSION CODE
 (F) = FUNCTION
 (M) = MATING
 (A) = AUDIT

FINISH EXTERIOR: MT11010
 FINE EDM
 INTERIOR: SP1-D2
 POLISH FINISH

SIZE	A
PREVIOUS DWG	
NEXT DWG	
FILENAME	C101074S1A.DWG

DWG NO.	C101074	REV	A
SCALE	NONE	SHEET	1 OF 4