

REVISIONS				
REV	SHT	DESCRIPTION	DATE	CHECKED
A	ALL	RELEASE NEW	6/30/02	RBS

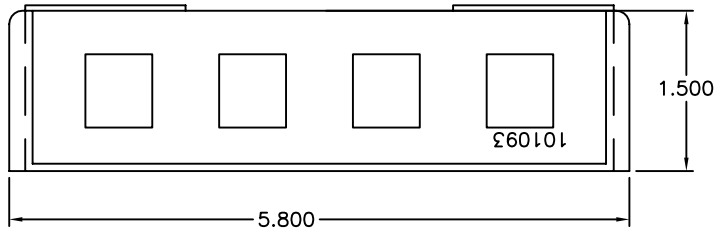

BACK VIEW

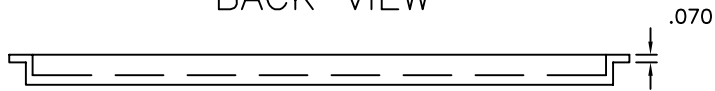

TOP VIEW

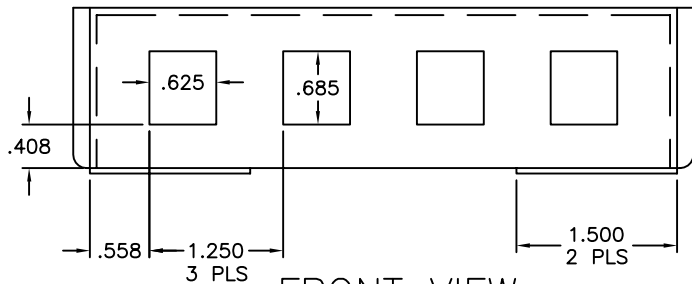

FRONT VIEW

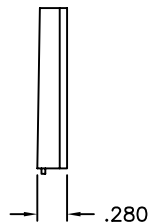

RIGHT SIDE

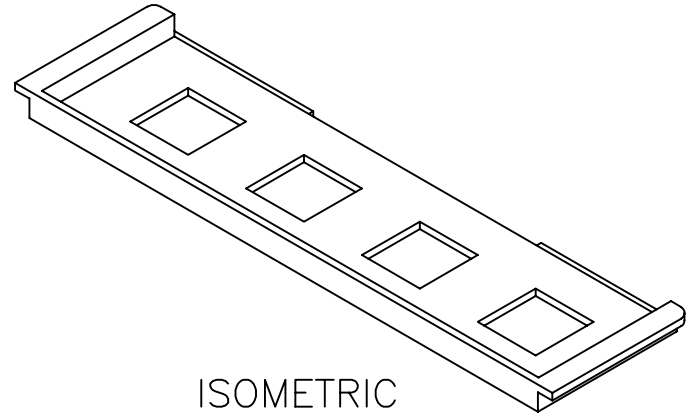

ISOMETRIC

**UNCONTROLLED COPY**

UNLESS OTHERWISE SPECIFIED  
DIMENSIONS ARE IN INCHES  
TOLERANCES:  
FRACTIONS  $\pm 1/32$ "  
ANGLES  $\pm 1/2$ "  
3 PLACE DECIMALS  $\pm .005$ "  
2 PLACE DECIMALS  $\pm .01$ "

THIS DRAWING AND THE DESIGN SHOWN ARE THE  
PROPERTY OF OPTICAL CABLE CORPORATION  
AND MAY NOT BE USED AS THE BASIS FOR MANU-  
FACTURE OR SALE WITHOUT SPECIFIC WRITTEN  
PERMISSION OF OPTICAL CABLE CORPORATION.

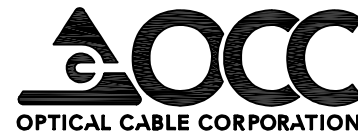

5290 Concourse Drive  
Roanoke, VA 24019  
Phone: 800-622-7711  
Fax: 540-265-0724  
www.occfiber.com

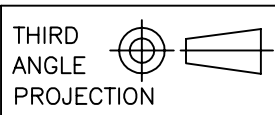

THIRD  
ANGLE  
PROJECTION

MATERIAL  
CATEGORY: THERMOPLASTIC  
COLOR SPEC: SEE OCC  
DRAWING #100004

CRITICAL DIMENSION CODE  
ⓕ = FUNCTION  
Ⓜ = MATING  
Ⓐ = AUDIT

FINISH  
EXTERIOR: MT11010  
FINE EDM  
INTERIOR: SP1-D2  
POLISH FINISH

DRAWN BY	D.A.HOLBERT	DATE	6/30/02
CHECKED BY	R.B.SMITH	DATE	7/8/02
ENGINEER	J.YANIK	DATE	6/30/02
APPROVED	H.JOHNSON	DATE	6/23/10
PREVIOUS DWG			
NEXT DWG			

DWG TITLE  
MULTIMEDIA PLATE,  
UMJ X 4 MTG

SIZE  
A

DWG NO. C101093

REV  
A

SCALE NONE

SHEET 1 OF 1

FILENAME C101093A.DWG